	Greenhouse Gas Lifecycle Assessment: Alaska LNG Project	3060-ENV-RTA-00001
		Revision No. 0
	PUBLIC	10/4/2021
		Page 1

# GREENHOUSE GAS LIFECYCLE ASSESSMENT: ALASKA LNG PROJECT

## ABSTRACT

A lifecycle analysis of greenhouse gas (GHG) emissions from the Alaska LNG Project was developed to provide a comparison of the project to other global energy options. Unique aspects of the project taken into consideration in the assessment included:

- Clearly-delineated upstream sources;
- Available measurements of actual GHG production in upstream locations;
- Co-production of gas with oil;
- One long, single pipeline transportation route; and
- A short liquefied natural gas (LNG) tanker route to expected export locations.

The assessment clearly shows the advantages of the Alaska LNG Project in comparison to coal for power generation in Asia. It also shows the project has lower carbon intensity than LNG shipped from current common locations such as the United States Gulf Coast and Australia.

## 1. INTRODUCTION

There is growing interest in decreasing the use of fossil fuels and assessing greenhouse gas (GHG) emissions.<sup>[1]</sup> However, at the same time it is clear alternative energy sources cannot yet provide for the world's energy needs. Additional infrastructure and new technologies are required for alternative sources to provide generation, storage, and transmission capacity for peak and growing energy demands.

Further, although GHG studies have repeatedly shown natural gas used for power generation has significantly (40-60%) lower GHG emissions when compared to coal-fired power generation,<sup>[2]</sup> market forces and variability in regulatory requirements are continuing to prompt the construction of hundreds of new coal plants. For example, about 58% of China's total energy consumption in 2019 came from coal, and in 2020 Chinese provinces granted construction approval for more than three times the coal power generation capacity permitted in 2019.<sup>[3]</sup>

Regulatory agencies have coordinated a review of the environmental impacts of the Alaska LNG Project as part of their permitting and approval processes. This review culminated in a comprehensive Final Environmental Impact Statement (FEIS) issued by the Federal Energy Regulatory Commission (FERC) in 2020 in compliance with the National Environmental Policy Act.

Recent studies<sup>[4,5]</sup> have highlighted the differences among various liquefied natural gas (LNG) projects depending on upstream sources, transportation means and distances, and other factors. The purpose of this study is to similarly assess GHG emissions across the entire lifecycle of the Alaska LNG Project based on project-specific data and to compare the emissions impact of the project to other global LNG and non-LNG power generation options.

## 2. METHODS

### 2.1. Alaska LNG Project Components and Boundaries

The GHG lifecycle analysis (LCA) for the Alaska LNG Project was developed to address the full range of

components upstream and downstream of the project including natural gas extraction, production, gathering and boosting (G&B), processing, compression, transmission pipeline, liquefaction, ocean transport, regasification, end-user pipeline transmission, and power generation/distribution.

The project supply chain components include:

- Upstream natural gas supply source and production from the existing Prudhoe Bay Unit (PBU) and Point Thomson Unit (PTU).
- Project components, including PTU and PBU Gas Transmission Lines, Gas Treatment Plant (GTP), Mainline pipeline, and Liquefaction Facility (LNG Plant and Marine Terminal).
- Gas treatment byproducts (carbon dioxide [CO<sub>2</sub>] and hydrogen sulfide) removed from the GTP feed gas that are compressed, dehydrated, and returned to the PBU for injection underground.

- Downstream components, including LNG ocean tanker transportation, regasification, and end-user transmission and power generation/distribution.

### 2.1.1. Study Boundaries and Block Diagram

Study boundaries were established to confirm the analysis addressed the full lifecycle, including upstream supply chain components associated with extracting natural gas from North Slope basins (PBU and PTU); processing, transmission and liquefaction via Project components; downstream transport to Asian markets (predominately China); and end use in Asia natural gas power production, transmission, and distribution. Study boundaries are shown in the block diagrams provided as Figures 1 and 2, below.

Emissions estimates for each stage of the supply chain were scaled based on the project design basis and associated natural gas material balance (natural gas input less process consumption and losses = natural gas output).

Figure 1. Alaska LNG Project and Upstream Gas Supply Block Diagram

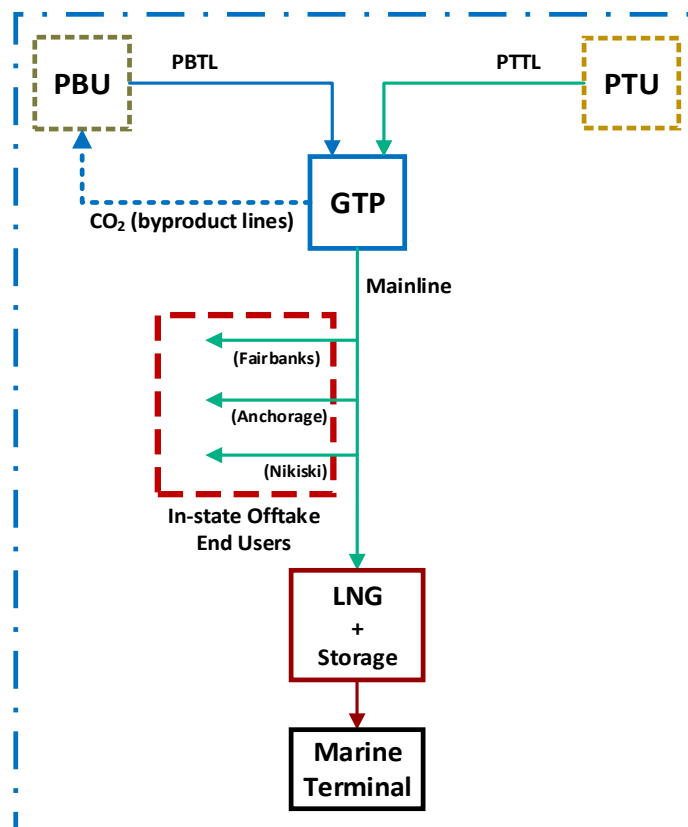
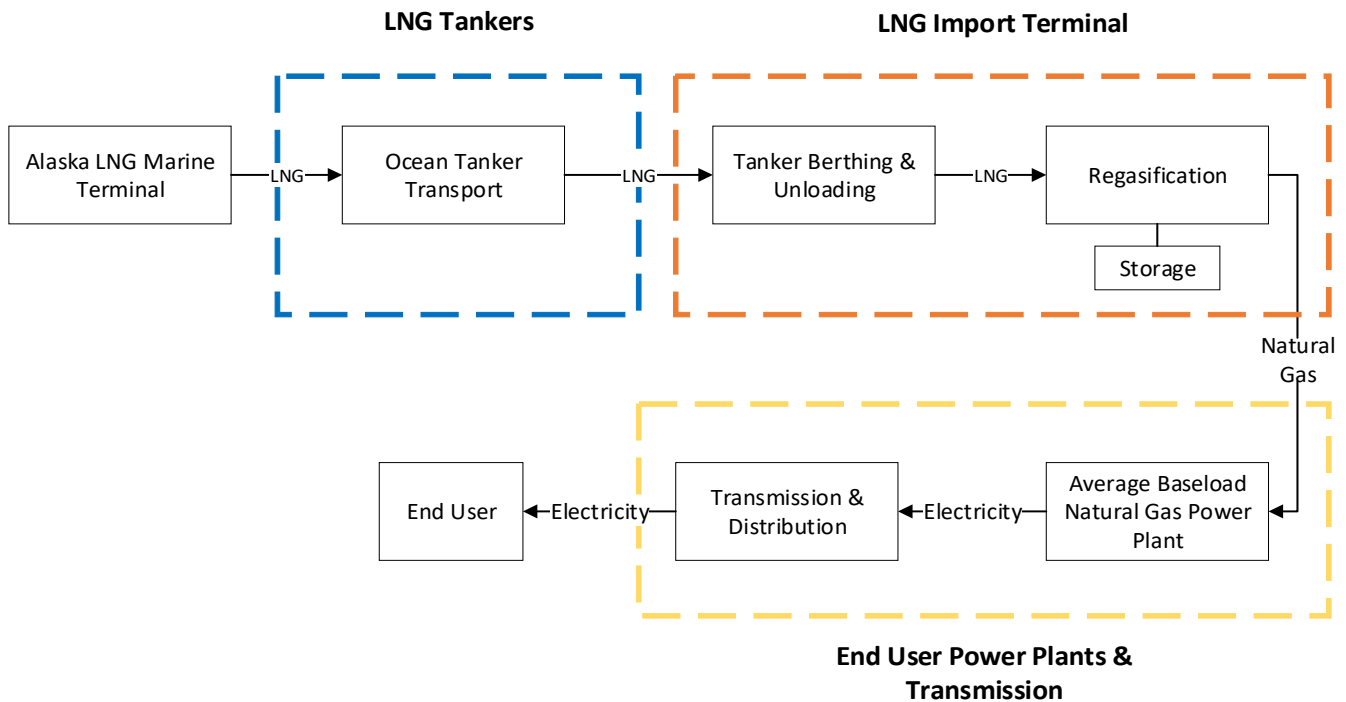

Figure 2. Downstream and End Use Components Block Diagram



## 2.2. LCA Framework and Approach

The LCA framework and approach were set up to be consistent with recent LCAs completed by the United States (U.S.) Department of Energy (DOE), National Energy Technology Laboratory (NETL),<sup>[1,6,7]</sup> with project-specific modifications to represent the unique elements of the Alaska LNG Project’s supply chain. Those elements include a contained supply basin operated in cold climate conditions using shared oil production facilities, a GTP that includes CO<sub>2</sub> byproduct separation and re-injection, a single transmission pipeline system, and proximity to Asian LNG market destinations.

The framework presented in this assessment used DOE NETL methods in conjunction with actual carbon-based GHG emission information for upstream components, as published in U.S. Environmental Protection Agency (EPA) emissions reports, project-specific estimates for project components, and published estimates for downstream components consistent with the

estimates used by the DOE NETL for similar LCAs. The LCA also used well-documented assumptions and methodologies consistent with other LCA studies, most notably those completed by DOE’s NETL.

### Actual Emissions for Upstream Gas Suppliers

In contrast to other LNG projects that export natural gas from multiple shale and other unconventional upstream basins, the sources of gas for the Alaska LNG Project are conventional, well-established producing basins. Gas for the project will come from two specific upstream fields, the PBU and PTU.

The PBU already produces oil and associated gas, and the gas is currently extracted, compressed, and reinjected into the field, as there is no available route to market. Emissions data relating to existing production are publicly available in the form of current GHG reports filed with EPA. Therefore, upstream GHG estimates for gas contributions from the PBU were developed using publicly available 2019 actual emissions data, as reported to the EPA, Greenhouse Gas Reporting Program (GGRP)<sup>[8]</sup> by the

operators of the natural gas suppliers within the existing PBU operating area.

Given the PBU basin co-produces oil and gas from extraction wells,<sup>[9]</sup> the emissions estimates were allocated for purpose of the LCA based on energy content such that the emissions associated with the extraction and production of the projected gas supply for the Alaska LNG Project could be quantified. This method is consistent with the 2019 LCA Natural Gas Extraction and Power Generation study,<sup>[7]</sup> which used a similar heat content apportioning method of associated gas emissions.

Additionally, the PBU upstream emissions estimates were adjusted to reflect the ramp-down of existing compressor turbine system emissions at the Central Compressor Plant (CCP) and Central Gas Facility (CGF) that would occur as PBU gas was provided to the Alaska LNG Project instead of being reinjected in the PBU reservoir.

For the PTU, FERC evaluated emissions<sup>[10]</sup> from the incremental processing facilities planned as part of the Major Gas Supply (MGS) phase required to meet the gas supply demand for the Alaska LNG Project as part of its comprehensive process for evaluating connected, non-jurisdictional facilities. Accordingly, the FERC MGS estimates were used in the LCA for the PTU.

### Project Component Design Basis Modeled Emissions

Alaska LNG GHG emissions for the GTP, transmission pipelines, and liquefaction components of the project were developed using detailed facility emission unit inventories and potential-to-emit (PTE) emissions estimates previously prepared for air quality analysis and modeling in the FERC Application, Resource Report 9, Air Quality and Noise, and utilized in FERC's FEIS.<sup>[10,11]</sup> That same source of information was used to support the Project's Alaska Department of Environmental

Conservation (ADEC) Air Quality Construction Permit applications for the GTP and Liquefaction Facility.

For consistency with the FERC FEIS and the 2019 EPA GGRP data, the LCA emissions estimates for upstream and project components are based on the Intergovernmental Panel on Climate Change (IPCC) Fourth Assessment Report (AR4)<sup>[12]</sup> 100-year (yr) global warming potentials (GWP) values. These GWP values for methane (CH<sub>4</sub> = 25) and nitrous oxide (N<sub>2</sub>O = 298) were used for calculating carbon dioxide equivalents (CO<sub>2</sub>e) [CH<sub>4</sub> = 25 gCO<sub>2</sub>e/gCH<sub>4</sub>, N<sub>2</sub>O = 298 gCO<sub>2</sub>e/gN<sub>2</sub>O, CO<sub>2</sub> = 1gCO<sub>2</sub>e/g CO<sub>2</sub>] for the LCA. It is recognized that other recent LCAs were based on the IPCC Fifth Assessment Report (AR5) GWP values, which increased the methane value to 36 gCO<sub>2</sub>e/gCH<sub>4</sub>.<sup>[2]</sup> However, given the small amount of CH<sub>4</sub> and N<sub>2</sub>O expected to be emitted from the Alaska LNG Project compared to CO<sub>2</sub> emissions as shown in Figure 3, the estimated CO<sub>2</sub>e emissions would not be significantly affected by varying the GWP values.

**Figure 3. Upstream and Project GHG Distribution**

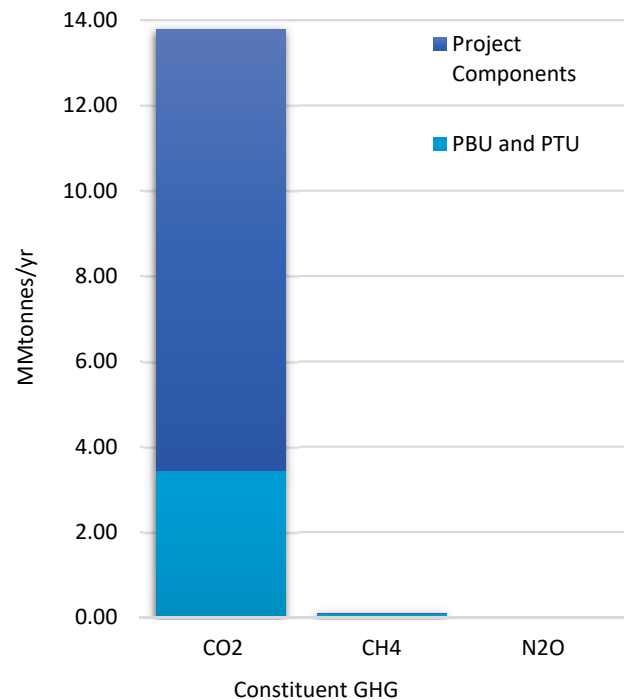

\* A comparison of the estimated PTE component emissions to the 2019 GGRP<sup>[8]</sup> reported emissions for the PTU indicates the MGS estimates are conservatively higher.

To estimate GHG emissions for the LCA, the Project PTE emissions were adjusted to take into account maximum possible flaring events based on the facility design (see details in Section 2.3.2).

**Public Source Data for Downstream Components**

Downstream component emissions estimates for LNG ocean tanker transportation, tanker berthing/deberthing, LNG regasification, and end user power production, transmission, and distribution were developed using data from the NETL reports and unit process data.<sup>[1, 13]</sup> Those data were scaled based on Alaska LNG Project’s projected production of 20 million tonnes per annum (MTPA), and subsequent shipment volumes to targeted Asian market destinations, for purposes of comparison to NETL and other LNG project LCAs.

**Normalizing Results for Comparison**

GHG emissions estimated for each supply chain component were added together to reflect total estimated annual emissions for the full lifecycle of the project. GHG intensities for each supply chain component were prepared using the estimated emissions per functional unit of 1 tonne LNG shipped

to a destination port and a mega-watt hour (MWh) of electricity generated in a destination market. The resulting GHG intensities were compared against the 2019 NETL LNG LCA report<sup>[1]</sup> and other LNG projects and LCAs.

**2.3. GHG Emissions Sources and Estimates by Supply Chain Components**

**2.3.1. Upstream Gas Supply Emissions Estimates**

As discussed above, upstream GHG estimates were developed using 2019 actual emissions reported to EPA for the various emission sources within the PBU operating area. Those emissions were then allocated based on energy content such that the emissions associated with the extraction and production of the projected Alaska LNG gas supply could be quantified. The resulting allocation of PBU emissions to the project was 30% of the reported 2019 EPA GGRP emissions. The estimated GHG emissions for the PTU MGS non-jurisdictional facilities developed for the FERC FEIS were used to represent likely upstream PTU emissions at the onset of Project operations.

The results are summarized in Figure 4.

**Figure 4. PBU and PTU Allocated Upstream GHG Emissions**

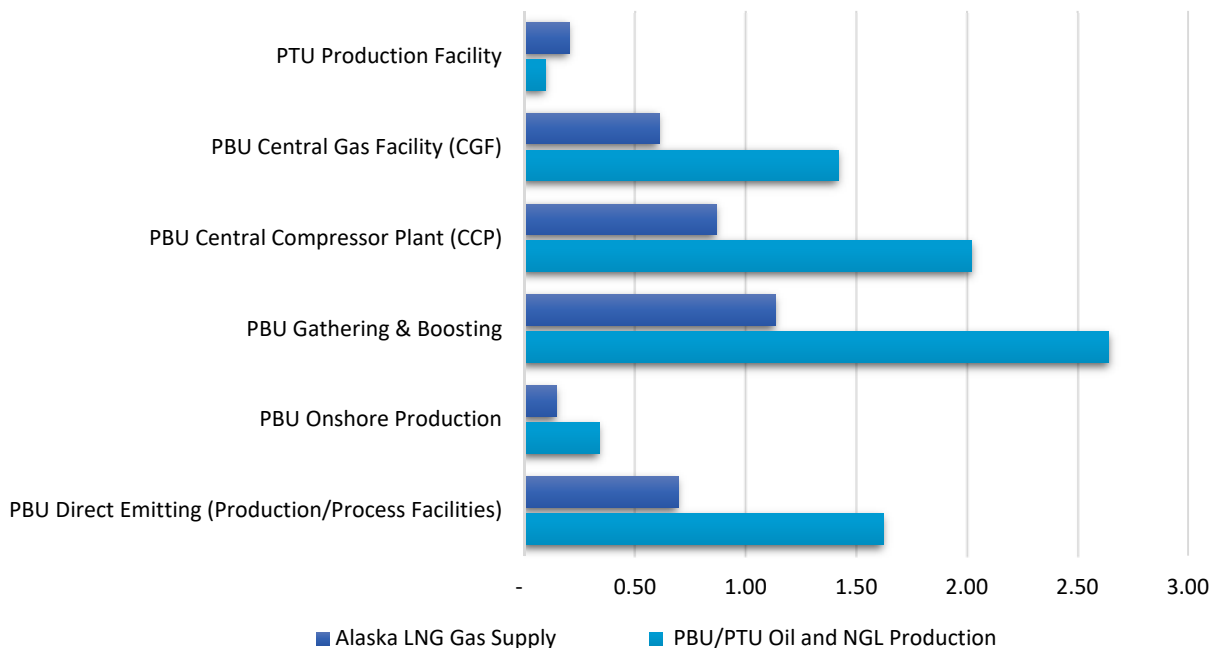

### PBU CCP/CGF Emissions Reductions from Ramp-Down of Gas Injection with MGS

The overall PBU operating emissions will be significantly reduced when the Alaska LNG Project begins operations due to the ramp-down of CCP and CGF emissions units (e.g., compressor turbines used to reinject gas), as a portion of the PBU gas will be supplied to the Project’s GTP. As shown in Figure 5, the ramp down of existing compressor turbines will result in multi-year emission reductions estimated to decrease CO<sub>2</sub>e emissions by more than 73 Mtonnes over a 30-yr operations period.<sup>[11]</sup> The significant PBU emissions reductions will offset the increased PTU MGS expansion emissions, resulting in net GHG emission reductions shown in Figure 5 and summarized in Table 1. For the purposes of this LCA, and to be consistent with the NETL heat content allocation approach, only a portion of the GHG reduction from decreased compression was applied to the Alaska LNG Project (Figure 5 and Table 1).

**Figure 5. Upstream PBU and PTU GHG Emissions Reductions from Baseline**

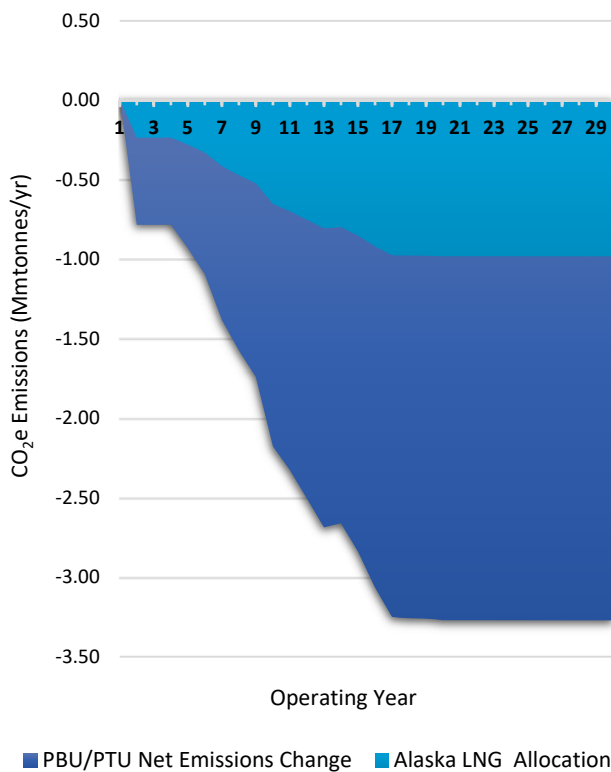
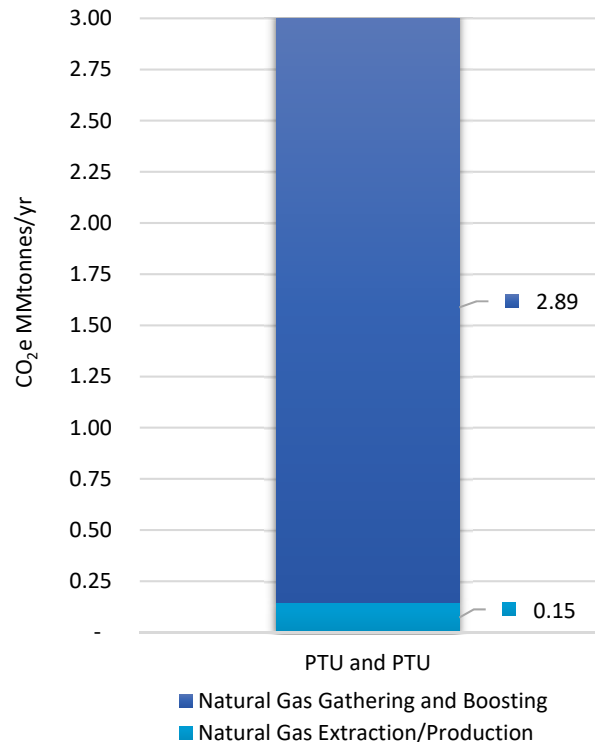

**Table 1. PTU/PBU Operations Net Emissions Reductions**

PTU Gas Expansion & PBU Operations GHG Emissions Reductions Net Change from Baseline	CO <sub>2</sub> e
Total Net Change from Baseline to startup +30 year operations (Mtonnes)	(73.07)
Average Yearly Net Change (Mtonnes/yr)	(2.44)
<b>Allocation to Alaska LNG Project Emissions (Mtonnes/yr)</b>	<b>(0.73)</b>

The GHG emissions for the Alaska LNG Project upstream supply chain are shown in Figure 6 on an operating basis. The numbers are totals for the facilities shown in Figure 6, grouped into the two primary supply chain components: extraction/production and G&B.

**Figure 6. Alaska LNG Upstream GHG Emissions Operating Basis**



### 2.3.2. GHG Emission Estimates for Project Components

Baseline project component GHG emissions were developed using air quality analyses and modeling from the Alaska LNG FERC Application, Resource Report 9, Air Quality and Noise.<sup>[11]</sup> The resulting PTE

data and reports were included in Resource Report 9 appendices<sup>[11]</sup> and are part of the public record included in the FERC Order and DOE Export License proceedings. That same source information was used to support the project’s ADEC Air Quality Construction Permit applications for the GTP and Liquefaction Facility.

For the LCA, PTE emissions were adjusted based on the maximum time flaring could occur on an operating basis as follows:

- LNG:
  - Two dry flares (no wet flares) per event<sup>[13]</sup>
  - Operating for a maximum of 72 hours/yr<sup>[14]</sup>

- GTP:
  - Only high-pressure and low-pressure hydrocarbon flares operating per event<sup>[11]</sup>
  - Operating for a maximum of 72 hours/yr

The GHG emissions for the Alaska LNG Project’s upstream and project supply chain operating basis is shown in Figure 7.

GHG intensities for each supply chain component were calculated using the estimated emissions per functional unit of 1 tonne LNG to be shipped via the Alaska LNG Project. The corresponding intensity based on the project’s projected production of 20 MTPA and shipment volumes to targeted Asian markets is shown in Figure 8.

**Figure 7. Alaska LNG Upstream & Project Supply Chain Operating Basis GHG Emissions**

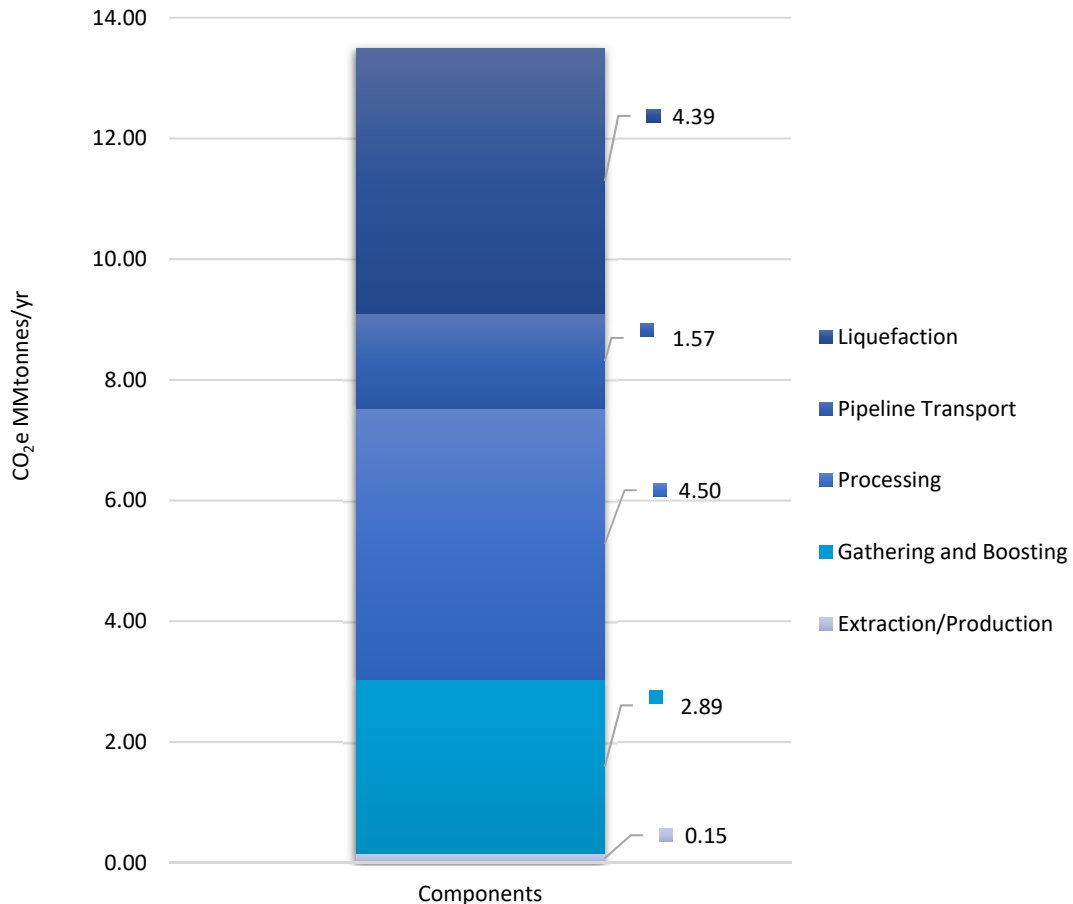
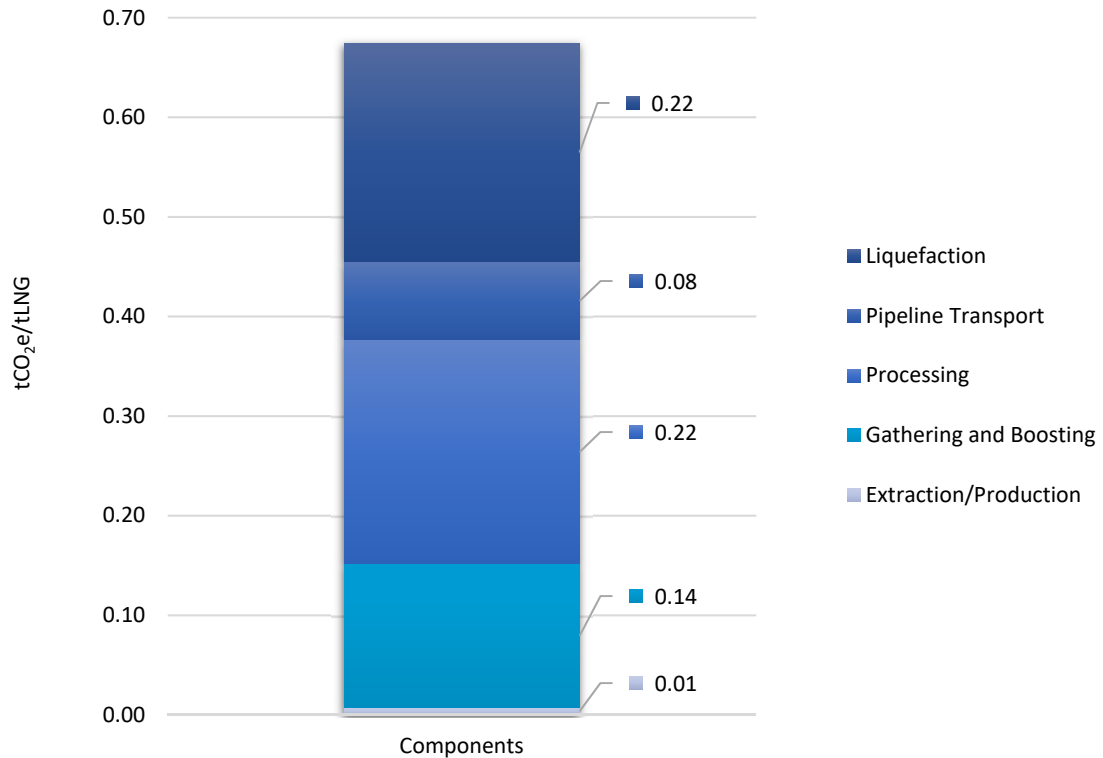

Figure 8. Alaska LNG Upstream & Project Supply Chain GHG Intensity



### 2.3.3. Downstream GHG Emissions

GHG emissions were estimated for the following supply chain components downstream from the Alaska LNG Marine Terminal, as outlined below.

- LNG ocean tanker transportation
- Tanker berthing and deberthing
- LNG regasification
- End user power production
- End user power transmission and distribution

The methods and source information used were selected to be consistent with the 2019 NETL LNG LCA report.<sup>[1]</sup>

#### LNG Ocean Tanker Transportation

Anticipated LNG delivery destinations were modeled by Alaska LNG to determine tanker travel distances, tanker fleet capacities required, and delivery distribution for the 20 MTPA LNG production. The estimated emissions were based on the modeled tanker destination distribution in Table 2.

Table 2. Alaska LNG Tanker Destination Distribution

Parameter	Alaska LNG Delivery Destination Distribution			
	Futtsu, Japan	Inchon, Korea	Shandong, China	Thi Vai, Vietnam
Distance (nm)	3,278	4,032	4,118	5,680
LNG Delivery (MTPA)	2	1.5	15	1.5

Tanker transport emissions were estimated using GHG intensity values associated with the New Orleans and Darwin to Shanghai LNG transport scenarios in the NETL report.<sup>[1]</sup> A weighted average GHG intensity by distance was calculated using Table A-2<sup>[1]</sup> values for the New Orleans and Darwin tanker transport distances and applied to the average tanker transport distance by number of deliveries of Alaska LNG to Asian destinations. The resulting GHG intensity in kilogram (kg) of CO<sub>2</sub>e per MWh (kg CO<sub>2</sub>e/MWh) was then converted to estimate gross emissions using the Alaska LNG project-based power emissions for 20 MTPA of delivered LNG.



### Tanker Berthing and Deberthing

Tanker berthing and deberthing emissions estimates were prepared using NETL’s deberthing unit process,<sup>[15]</sup> as applied to the estimated Alaska LNG 20 MTPA tanker fleet delivery amount.

### LNG Regasification, End User Power Production, and Transmission/Distribution

LNG regasification, end user power production, and electricity transmission/distribution emissions were obtained from NETL,<sup>[1]</sup> Table A-2 GHG Intensity values, and extrapolated to the Alaska LNG Project using estimated project-based power generation consistent with the approach used for tanker transportation. Results are summarized in Figure 9.

**Figure 9. Downstream GHG Emissions from Alaska LNG through End Use Power Production and Distribution**

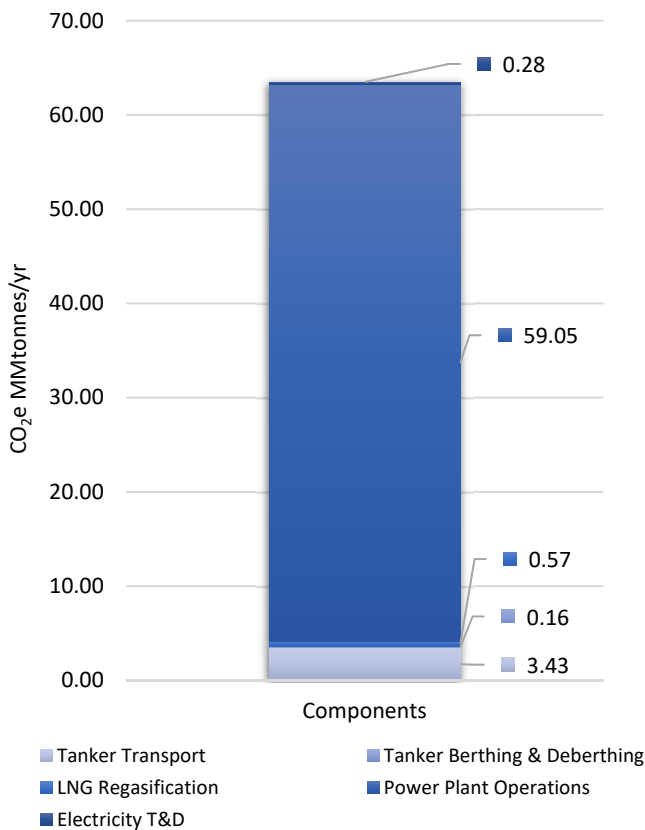

The GHG emissions from each component of the Alaska LNG supply chain are shown in Figure 10. The GHG emissions for each supply chain component

were added together to reflect total estimated annual emissions for the LCA.

**Figure 10. Alaska LNG Supply Chain to Asian Markets GHG Emissions**

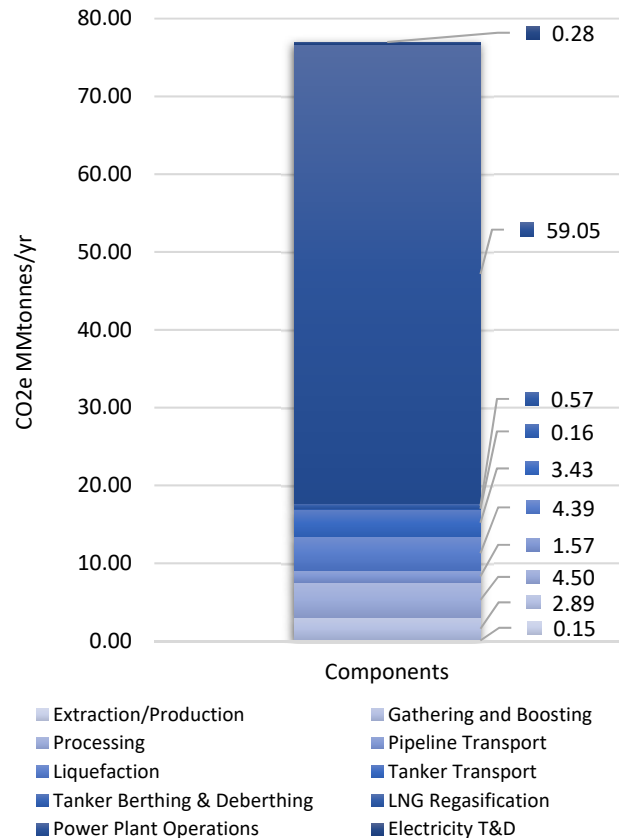

### 2.3.4. China Regional Coal Supply Chain GHG Emissions

For purposes of comparing the Alaska LNG Project lifecycle emissions to the current coal energy production in Asia, GHG emissions were estimated for a representative China Regional Coal supply chain system, consistent with the NETL<sup>[1]</sup> study approach. Specifically, emissions were estimated using the Table A-2<sup>[1]</sup> GHG intensity values in combination with the Alaska LNG project-based power generation from 20 MTPA LNG delivery. Figure 11 shows the combined emissions for each coal power production supply chain component to generate the same amount of energy as the Alaska LNG Project.

**Figure 11. Chinese Regional Coal Supply Chain GHG Emissions**

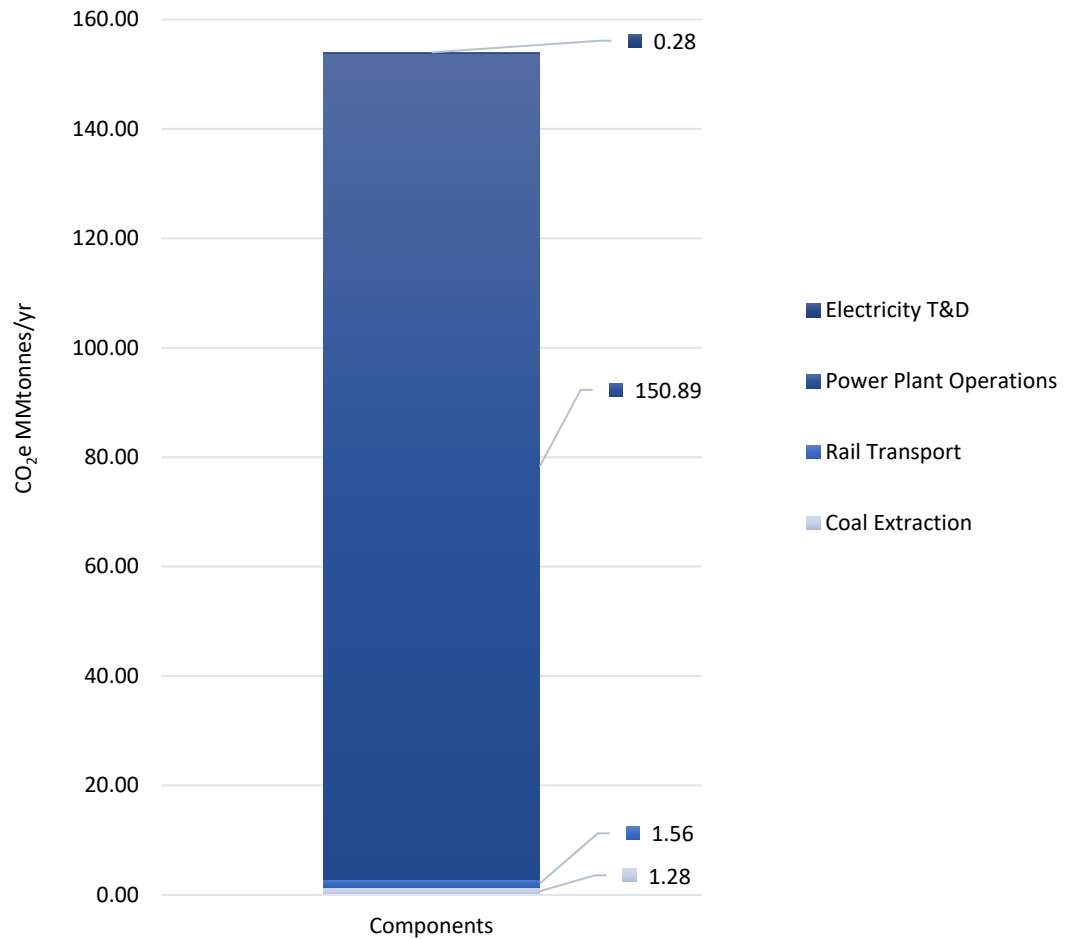

### 3. RESULTS AND DISCUSSION

#### 3.1. Alaska LNG Project LCA

GHG intensities for each supply chain component were prepared using the estimated emissions per functional unit of 1 tonne LNG shipped to a destination port and a MWh of electricity generated in a destination market. The functional unit per tonne of LNG shipped was used to evaluate and compare GHG intensities for the natural gas process flows from upstream gas extraction to downstream regasification, as shown in Figure 12. Carbon intensity units of emissions per energy produced (kg

of CO<sub>2</sub>e per MWh) were used to compare natural gas cradle to end use based on the amount of natural gas delivered to destination Asia markets (China) for end use power production and transmission.

The estimated power produced by LNG from the Alaska LNG Project was developed using the *National Average Heat Rate for Natural Gas Power Plants, Exhibit C-6, NETL 2019/2039*.<sup>[7]</sup> The average heat rate of 7,670 MJ for the fleet baseload power plant was applied to the Alaska LNG Project estimate.

**Figure 12. Alaska LNG Supply Chain to Regasification at Asian Markets GHG Intensity**

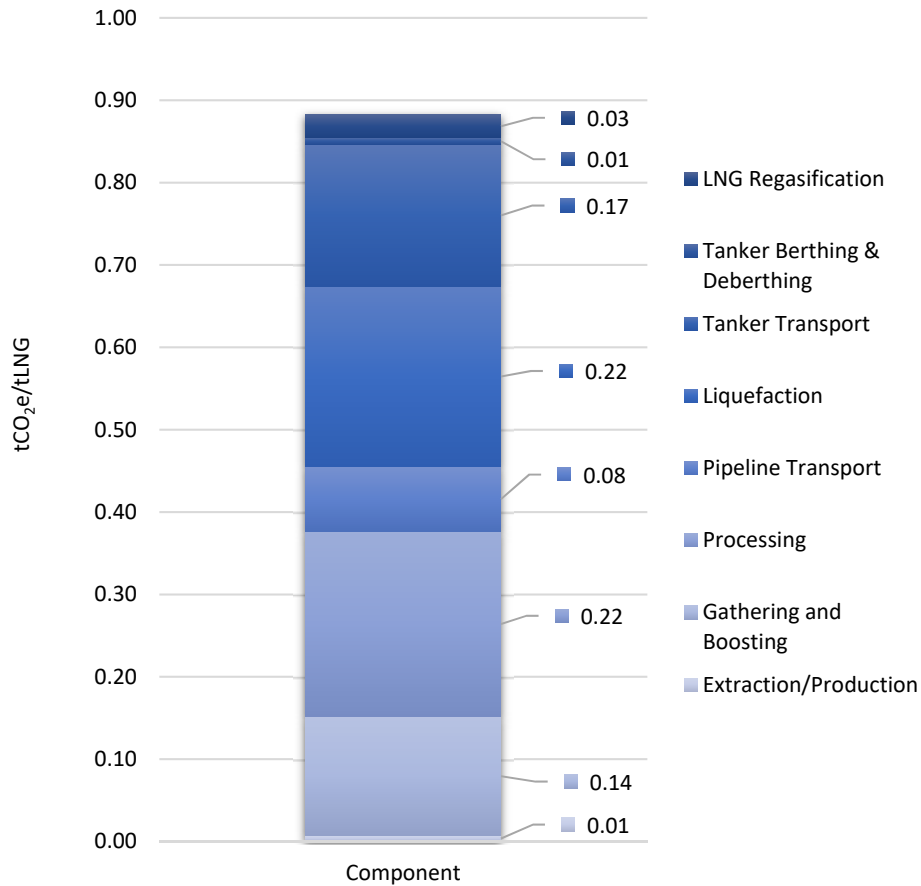

### 3.2. Comparisons

The Alaska LNG Project LCA results were compared to target market power production supply chains to assess the GHG intensity differences and evaluate whether there were benefits transitioning to natural gas power. Additional comparisons were made to other LNG supply chain projects and delivery scenarios from recently completed LCA studies.

#### 3.2.1. Alaska LNG Natural Gas vs Chinese Coal Power Generation

The GHG intensity values were developed based on the methodology described in Section 2.3.4 for the representative Chinese Regional Coal supply chain. The results were compared against the Alaska LNG Project natural gas supply chain and are summarized in Figure 13. The comparison also included values from a similar LCA study by ICF.<sup>[4]</sup>

The total estimated GHG emissions for the Alaska LNG Project from natural gas extraction through power distribution in comparison to the use of Chinese regional coal are shown in Figure 14. The majority of GHG emissions in the LCA of both Alaska LNG and coal-based power generation is the power generation process itself, which is a function of power plant efficiencies and the associated fuel types. For the Alaska LNG Project, power generation accounts for 77% of the total GHG emissions, whereas power generation from Chinese regional coal is about 98% of the total GHG emissions. The total lifecycle GHG emissions for Alaska LNG natural gas is 50% less (77 million tonnes CO<sub>2</sub>e/yr) than Chinese regional coal for a comparable amount of power production.

**Figure 13. Lifecycle GHG Intensity for Alaska LNG Natural Gas vs Coal Power**

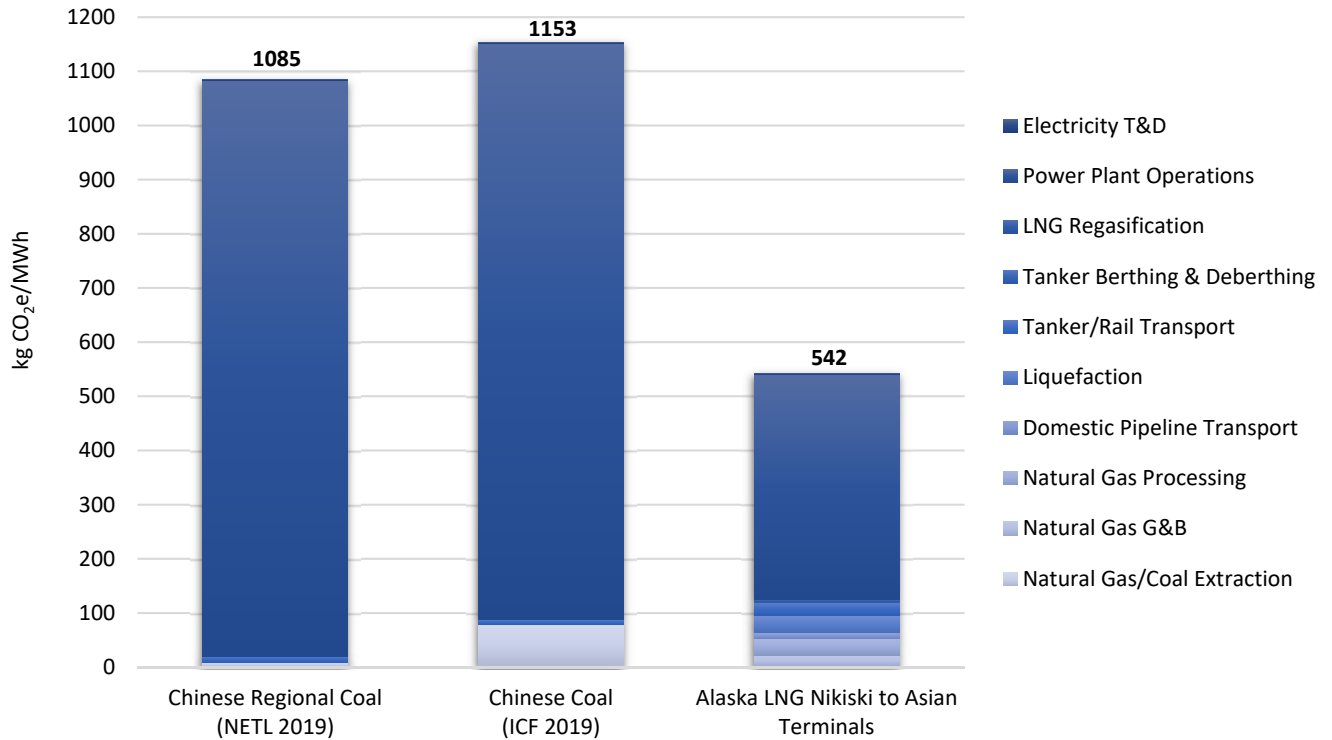

**Figure 14. Chinese Coal Comparison to Alaska LNG Natural Gas GHG Emissions**

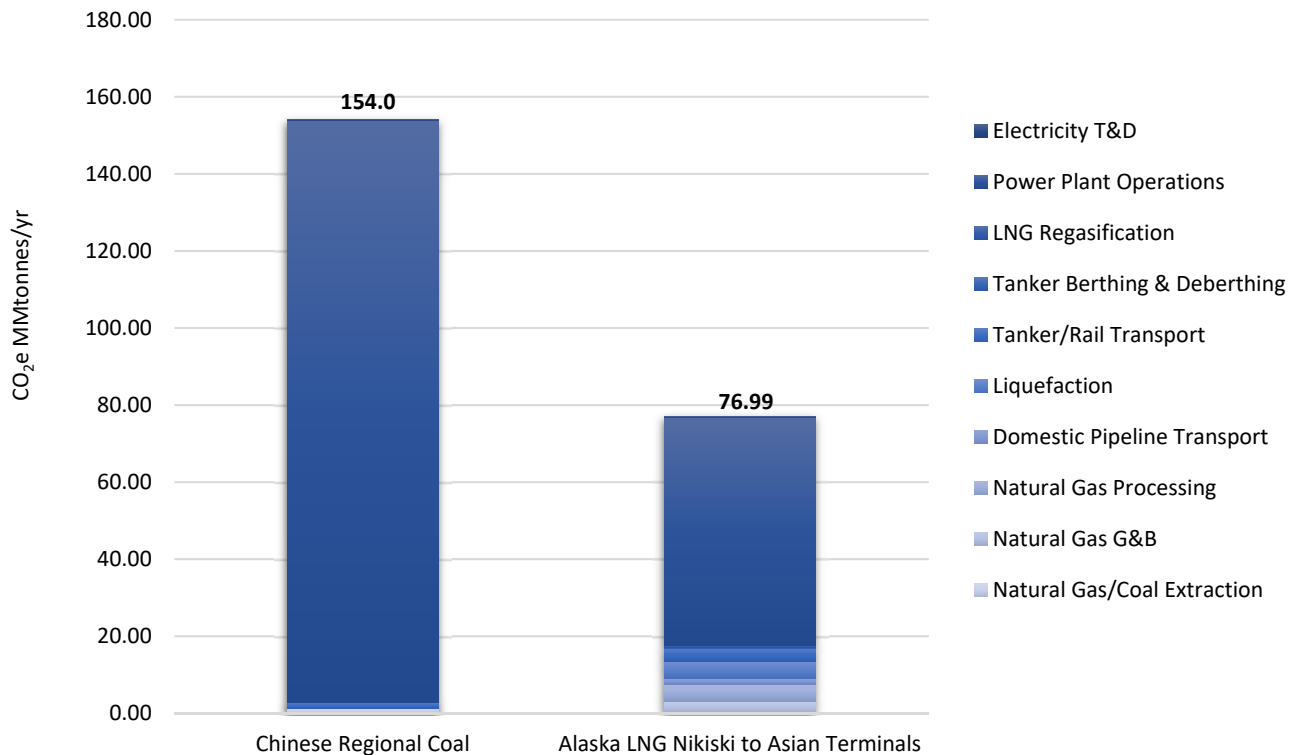

	Greenhouse Gas Lifecycle Assessment: Alaska LNG Project	3060-ENV-RTA-00001
		Revision No. 0
	PUBLIC	10/4/2021
		Page 13

### 3.2.2. Alaska LNG LCA Comparison to Other LNG Projects

The lifecycle GHG intensity estimated for the Alaska LNG Project was compared to the LNG scenarios analyzed in the NETL report.<sup>[1]</sup> The NETL assessment includes LNG transported from New Orleans to Shanghai, China and Darwin, Australia to Shanghai, China. In addition, the Cheniere Sabine Pass Liquefaction (SPL) facility was added to the comparison, as a LCA for that project was recently published.<sup>[5]</sup>

To facilitate the comparison on an LNG-delivered basis, the NETL projects, Cheniere SPL, and the Alaska LNG Project carbon intensities were converted to a standardized value of tonnes of CO<sub>2</sub>e per metric tonne of LNG (CO<sub>2</sub>e tonnes/tonne of LNG).

The resulting comparison is summarized in Figure 15 and key findings are discussed below.

The GHG intensity of the Alaska LNG Project is significantly lower than that of the two scenarios assessed by NETL and lower than the Cheniere SPL LNG. Notable differences are attributed to the following:

- Natural gas produced in PBU and PTU is associated gas that includes co-products of oil and water that share the extraction, G&B facilities, and associated emissions.
- Unconventional (Appalachian shale from New Orleans shipment) gas in the NETL 2019 study has more wells and higher emissions from boosting than the Alaska LNG Project.
- Conventional gas (Darwin, Australia) in the NETL 2019 study lacks the efficiencies gained from shared processing with oil identified for the Alaska LNG Project.
- The NETL study scaled the pipeline transport emissions based on multiple pipeline networks. Accordingly, the resulting modeled emissions were based on a pipeline

transmission scenario of 600 miles of pipelines with 10.2 transmission stations. The Alaska LNG Mainline is an 800-mile single pipeline with only 8 compressor stations, which result in lower fugitive and compression combustion emissions. The corresponding estimated GHG intensity is less than Cheniere and NETL intensities by a factor of two and five, respectively.

- The Alaska LNG GHG intensity is lower than Cheniere SPL for the natural gas extraction/production component. Natural gas extraction and production estimates are lower likely due to the fact the Cheniere facilities have no co-produced oil and, therefore, no sharing of the extraction, G&B facilities, and associated emissions for the SPL project.
- The Cheniere SPL tanker transport emissions are higher than Alaska LNG due to the significantly longer ocean transportation distances from the U.S. Gulf Coast to Asian market destinations in comparison to shorter routes from Alaska to Asian markets.

**Figure 15. Natural Gas Lifecycle GHG Intensities Production through Regasification**

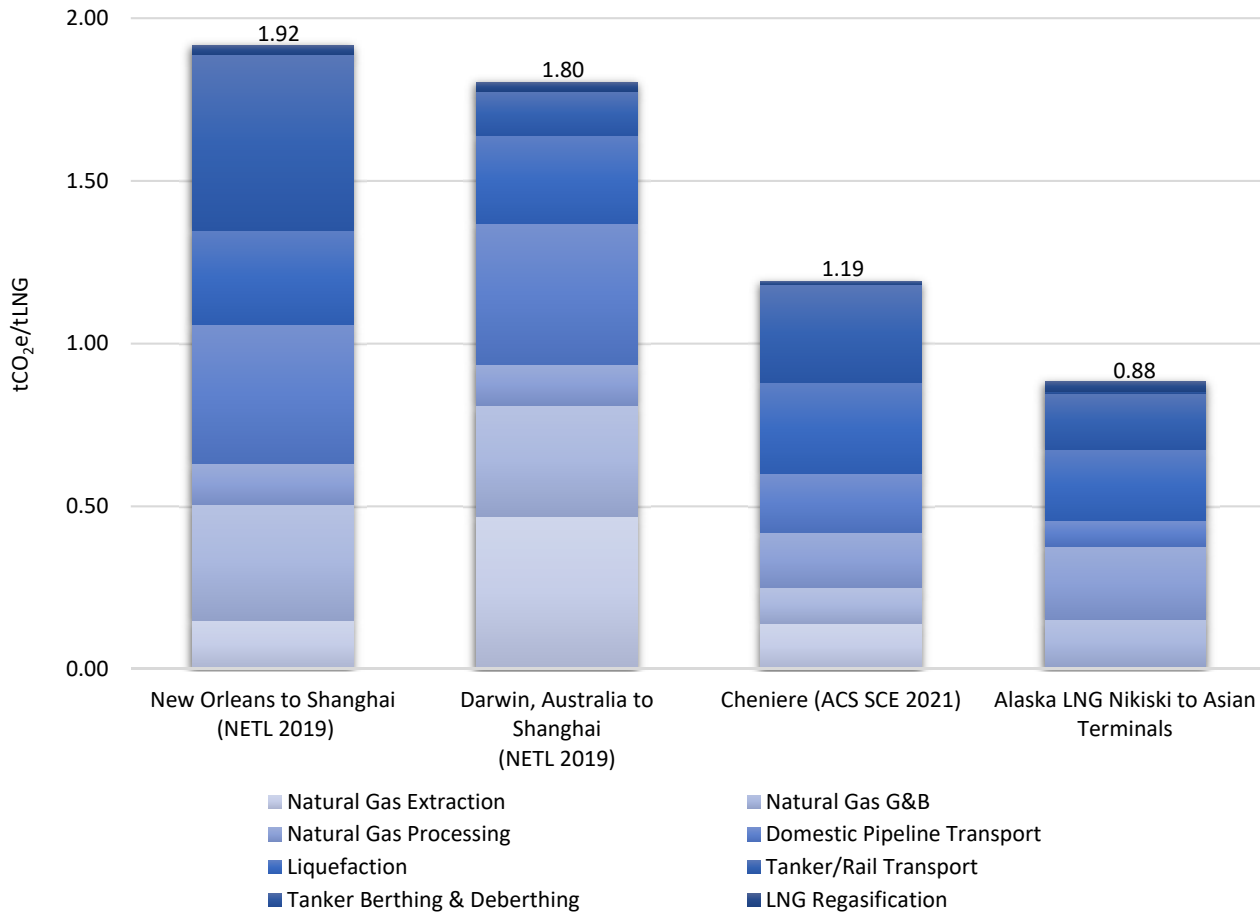

#### 4. CONCLUSIONS

The Alaska LNG Project GHG LCA was developed to provide a comparison of the project to other global energy options.

The supply chain LCA for exporting natural gas to Asian markets showed that overall GHG emissions for Alaska LNG natural gas are 50% less (77 million tonnes CO<sub>2</sub>e/yr) than Chinese regional coal.

A comparison with other LCA studies with similar LNG export supply chains showed the Alaska LNG Project had a lower GHG intensity primarily due to lower upstream emissions (e.g., extraction, production, G&B), pipeline transmission, and ocean tanker transportation components. These lower

values are attributable to the unique Alaska LNG Project aspects that include:

- Associated produced gas that includes co-products of oil and water that share the existing extraction and G&B facilities from confined operating oil and gas basins on the North Slope of Alaska. Further, exporting natural gas will reduce emissions from existing PBU facilities that currently compress and reinject natural gas because the gas is currently a stranded asset (no route to market) that must be managed in the course of oil production. The Alaska LNG Project will reduce natural gas emissions associated with these additional gas-handling steps.

	Greenhouse Gas Lifecycle Assessment: Alaska LNG Project	3060-ENV-RTA-00001
		Revision No. 0
	PUBLIC	10/4/2021
		Page 15

- The Alaska LNG Mainline is an 800-mile single pipeline with only 8 compressor stations, which results in lower fugitive and compression combustion emissions compared with other projects that are receiving gas from multiple pipeline systems with more combined compressor stations.
- The Alaska LNG Project’s ocean tanker transportation distances are significantly shorter to Asian market destinations. Alaska’s shipping route to Asia is approximately 14 days shorter than from the U.S. Gulf Coast.

---

## 5. LIST OF REFERENCES

- [1] Roman-White, S.; Rai, S.; Littlefield, J.; Cooney, G.; Skone, T.J. *Life Cycle Greenhouse Gas Perspective on Exporting Liquefied Natural Gas from the United States: 2019 Update*; National Energy Technology Laboratory, 2019; DOE/NETL-2019/2041, 1607677.
- [2] Intergovernmental Panel on Climate Change (IPCC). *Climate Change 2014: Mitigation of Climate Change. Contribution of Working Group III to the Fifth Assessment Report of the Intergovernmental Panel on Climate Change* [Edenhofer, O., R. Pichs-Madruga, Y. Sokona, E. Farahani, S. Kadner, K. Seyboth, A. Adler, I. Baum, S. Brunner, P. Eickemeier, B. Kriemann, J. Savolainen, S. Schlömer, C. von Stechow, T. Zwickel and J.C. Minx (eds.)]. Cambridge University Press, Cambridge, United Kingdom and New York, NY, USA, 2014; pp 1-1454.
- [3] Standaert, M., Despite Pledges to Cut Emissions, China Goes on a Coal Spree, Yale Environment360, Published at the Yale School of the Environment, March 2021. Available at <https://e360.yale.edu/features/despite-pledges-to-cut-emissions-china-goes-on-a-coal-spree>.
- [4] ICF. *Update to the Life-Cycle Analysis of GHG Emissions for US LNG Exports Analysis*, Submitted to American Petroleum Institute. July 2020.
- [5] Roman-White, S.; Littlefield, J.; Fleury, K; Allen, D.; Balcombe, P.; Konschnik, K; Ewing, J.; Ross, G.; and George, F. *LNG Supply Chains: A Supplier-Specific Life-Cycle Assessment for Improved Emission Accounting*. ACS Sustainable Chemistry & Engineering 2021 9(32), 10857-10867 DOI: 10.1021/acssuschemeng.1c03307
- [6] Skone, T. J.; Littlefield, J. Marriott, J.; Cooney, G.; Jamieson, M.; Hakian, J.; Schivley, G. *Life Cycle Analysis of Natural Gas Extraction and Power Generation*; NETL: Pittsburgh, PA, 2014; pp 1–200.
- [7] Littlefield, J.; Roman-White, S.; Augustine, D.; Pegallapati, A.; Zaines, G. G.; Rai, S.; Cooney, G.; Skone, T. J. *Life Cycle Analysis of Natural Gas Extraction and Power Generation*; National Energy Technology Laboratory, 2019.
- [8] Environmental Protection Agency (EPA). *2019 Greenhouse Gas Reporting Program Data Sets*. <https://www.epa.gov/ghgreporting/ghg->

	Greenhouse Gas Lifecycle Assessment: Alaska LNG Project	3060-ENV-RTA-00001
		Revision No. 0
	PUBLIC	10/4/2021
		Page 16

- [reporting-program-data-sets](#). Accessed June 2021.
- [9] Alaska Oil and Gas Conservation Commission. *2020 Production for North Slope*, Data Miner. <https://www.commerce.alaska.gov/web/aogc/Data.aspx>. Accessed July 2021.
- [10] Federal Energy Regulatory Commission (FERC). *Alaska LNG Project Final Environmental Impact Statement*, March 2020, FERC/EIS-0296F. Available at <https://www.ferc.gov/industries-data/natural-gas/final-environmental-impact-statement-0>.
- [11] Alaska LNG Project. *Application of Alaska Gasline Development Corporation for Authorization Under Section 3 of the Natural Gas Act*, Resource Report 9, including Appendix D: Liquefaction Facility Air Quality Modeling Report; Appendix E: Main Pipeline Compressor Stations Air Quality Modeling Report; Appendix F: Gas Treatment Plant Air Quality Modeling Report; Appendix G: Non-Jurisdictional Facilities Air Quality Report; FERC Docket No. CP17-178-000, April 2017. Accession No. 20170417-5345. Accessible on the FERC website at <http://www.ferc.gov>. Using the “eLibrary” link, select “Advanced Search” from the eLibrary menu and enter 20170417-5345 in the “Numbers: Accession Number” field.
- [12] IPCC. *100-year GWPs from Fourth Assessment Report (AR4)*, 2007.
- [13] Alaska Gasline Development Corporation. Response to Alaska Department of Environmental Conservation Liquefaction Plant Air Quality Construction Permit AQ1539CPT01 Information Request, dated October 9, 2020.
- [14] Alaska Gasline Development Corporation. Response to FERC Environmental Data Request RFI-466-RR09-031, Accession No. 20171201-5211. December 1, 2017.
- [15] National Energy Technology Laboratory (NETL). *NETL Life Cycle Inventory Data – Unit Process: LNG Tanker\_Docking\_Berthing\_Deberthing*. U.S. Department of Energy, National Energy Technology Laboratory. Last Updated: October 2010 (version 01). Available online at <http://www.netl.doe.gov/energy-analyses>.